



PRODUCT RANGE







Since its foundation in 1991 HIPAC has focused exclusively on one packaging sector, with the aim of becoming “the” specialist for stretch film.

Hipac produces high performance stretch films, tailored to protect any type of industrial good during storage and transportation.



HI LAB



HI LAB is the Research and Development centre of the Group.
A state-of-the-art laboratory,
equipped with all the latest generation instruments
for the physical and mechanical analysis of stretch film.

PRODUCTS OVERVIEW



STRETCH FILMS FOR PALLET WRAPPING AND COLD BUNDLING.

HIPAC TRADITIONAL STRETCH FILMS		HIPAC PREMIUM STRECHT FILMS	
WRAPPING MACHINES WITHOUT PRESTRETCH GROUP OR HAND WRAP	WRAPPING MACHINES WITH PRESTRETCH GROUP	WRAPPING MACHINES WITHOUT PRESTRETCH GROUP OR HAND WRAP	WRAPPING MACHINES WITH PRESTRETCH GROUP
310 - BASIC (125%)	888 - POWER (220%)	555 - RIGID (120% - 15 µm)	333 - RIGID POWER (240% - 15 µm)
308 - STANDARD (145%)	777 - POWER PLUS (270%)		111 - SUPER POWER (350%)
388 - STANDARD PLUS (165%)		999 EXTRA RIGID - (15% - 8 µm)	112 - SUPER POWER PLUS (> 400%)
		COLLATION® STRETCH	C200 - C400 - C600 SERIES

Figures refer to 23 µm film (unless otherwise specified)



HI GREEN

Sustainable solutions for the implementation of circular economy and the reduction of the carbon footprint. Our vision for a greener future.

IRELIVE

Stretch films made of Post Consumer and/or Post industrial Recycled materials, mechanically recycled from highly selected waste materials of the stretch application.

IRENEW

Stretch films made of Polyethylene obtained from renewable, non-fossil sources.

IREOLVE

Biodegradable, non-compostable stretch film, in compliance with ISO 15985 international standard and equivalent.

NETROLL®

Available for all the product range, the technology to produce reels without a paper core.

Zero waste materials.

310

BASIC

FOR HAND WRAPPING
AND
WRAPPING MACHINES
WITHOUT PRESTRETCH

308

STANDARD

388

STANDARD PLUS

TRADITIONAL

Our traditional films
for standard applications



Fully
recyclable



Safe
transportation



Protection
of the goods



BASIC "ENTRY - LEVEL"
STRETCH FILM

STRETCH 125% (FOR 23 μ m)

310
BASIC

STANDARD STRETCH FILM
FOR GENERAL APPLICATION

STRETCH 145% (FOR 23 μ m)

308
STANDARD

STANDARD PLUS STRETCH FILM
WITH HIGH RESISTANCE
TO PERFORATION

STRETCH 195% (FOR 23 μ m)

388
STANDARD PLUS

SUGGESTIONS

Regular
pallet (A)



310 23 μ m
308 20 μ m
388 17 μ m

Slightly irregular
pallet (B)



308 23 μ m
388 20 μ m

Very irregular
pallet (C)



388 23 μ m

OUR PREMIUM UPGRADE

555

RIGID

PREMIUM

HALF THICKNESS
vs STANDARD FILM
SAME PERFORMANCE

Discover 555 at page 10

USAGE INFORMATION



Rotating
table



Robot

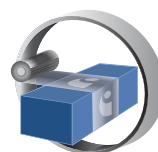

Horizontal
rotating ring

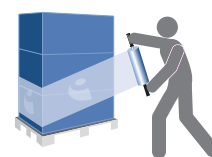

Hand
wrapping

888
888
POWER

FOR WRAPPING
MACHINES
WITH **PRESTRETCH**

777
POWER PLUS

TRADITIONAL

Our traditional films
for power applications



Fully
recyclable



Safe
transportation



Protection
of the goods



POWER FILM FOR "ENTRY - LEVEL"
WRAPPING MACHINES
WITH MEDIUM PRESTRETCH

PRESTRETCH 240% (FOR 23µm)

888
POWER

POWER PLUS FILM WITH HIGH
PRESTRETCHABILITY AND
IMPACT RESISTANCE

PRESTRETCH 270% (FOR 23µm)

777
POWER PLUS

SUGGESTIONS

Regular
pallet (A)



888 20 µm
777 17 µm

Slightly irregular
pallet (B)



888 23 µm
777 20 µm

Very irregular
pallet (C)



777 23 µm

OUR PREMIUM UPGRADE

333

PREMIUM

TO REPLACE
POWER FILM
SAVING UP TO
35% MATERIAL

111

PREMIUM

TO REPLACE
POWER FILM
SAVING UP TO
25% MATERIAL

Discover 333 at page [12](#)

Discover 111 at page [14](#)

USAGE INFORMATION



Rotating
table

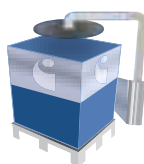

Rotating
arm



Robot

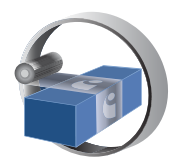

Horizontal
rotating ring

555

RIGID

FOR HAND WRAPPING
AND FOR
WRAPPING MACHINES
WITHOUT PRESTRETCH

PREMIUM

Our sustainable solution to replace traditional standard films allowing **thickness downgauging** whilst maintaining the **stability** and the safety **of the load unit**.

The lower film consumption can **reduce your packaging costs by up to 40%**



Fully recyclable



Easy and comfortable hand application



Safe transportation



40% cost saving



Protection of the goods



Reduction of CO₂ emissions

PREMIUM FILM 555 RIGID ALLOWS 50% THICKNESS DOWNGAUGING COMPARED TO TRADITIONAL STANDARD FILMS

HALF THICKNESS SAME PERFORMANCE



TECHNICAL INFORMATION

555 RIGID maintains the same pallet stability as **your standard film**

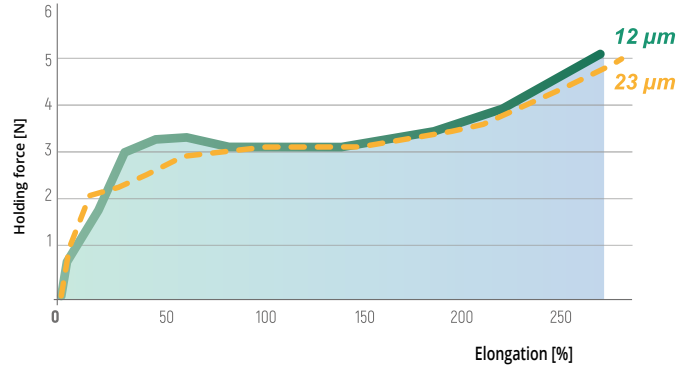

SUGGESTIONS

STANDARD FILM

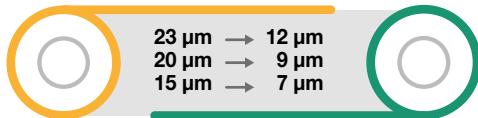

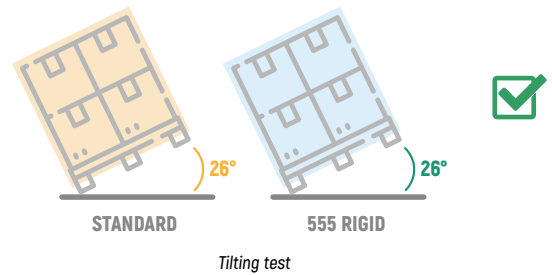

555 RIGID

THE LOAD UNIT IS IN COMPLIANCE WITH EN 12195 GUIDELINES



CUSTOMER FIELD TEST - BUILDING MATERIALS

		PRODUCT	THICKNESS	NUMBER OF WRAPS	HOLDING FORCE	HOLDING FORCE DIFFERENCE	FILM CONSUMPTION	FILM SAVING
	Rotating table Stretch: 30%	STANDARD FILM	23 µm	11	15.3 kg		383 g	
	LOAD UNIT TYPE Profile "A", regular Weight: 650 kg	HIPAC 555	12 µm	11	15.7 kg	+ 3%	168 g	56%

USAGE INFORMATION



Rotating table



Robot

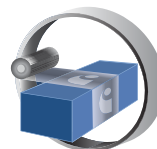

Horizontal rotating ring



Hand wrapping

333

RIGID POWER

FOR "ENTRY LEVEL"
WRAPPING MACHINES
WITH **MEDIUM PRESTRETCH**

PREMIUM

Our sustainable solution to replace traditional power films allowing **thickness downgauging** whilst maintaining the **stability** and the safety of **the load unit**.

The lower film consumption can
**reduce your
packaging costs by up to
30%**



Fully
recyclable



No changes on the
wrapping machine



Safe
transportation



30%
cost saving



Protection
of the goods



Reduction
of CO₂ emissions

PREMIUM FILM 333 RIGID POWER ALLOWS 35% THICKNESS DOWNGAUGING COMPARED TO TRADITIONAL POWER FILMS



TECHNICAL INFORMATION

333 RIGID POWER maintains the same pallet stability as **your power film**

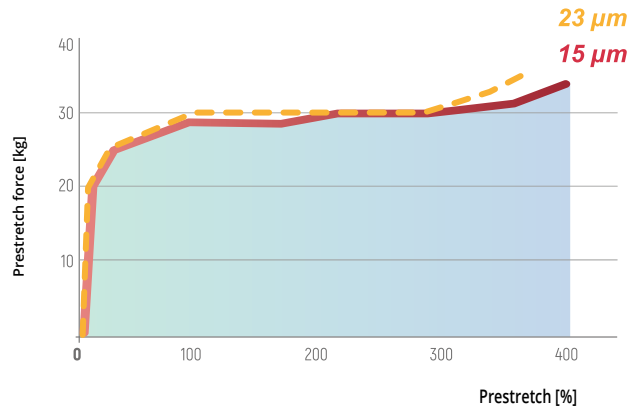

SUGGESTIONS

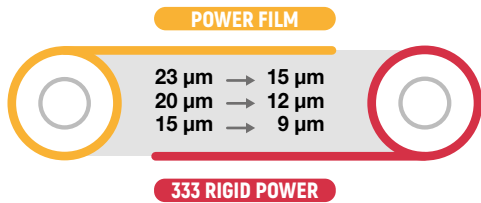

THE LOAD UNIT IS IN COMPLIANCE WITH EUMOS 40509

0,5g

Acceleration Bench Test

CUSTOMER FIELD TEST - BEVERAGE

	PRODUCT	THICKNESS	NUMBER OF WRAPS	HOLDING FORCE	HOLDING FORCE DIFFERENCE	FILM CONSUMPTION	FILM SAVING
	Rotating arm Prestretch: 150%	POWER FILM	23 µm	26	11.65 kg	435 g	
	LOAD UNIT TYPE Profile "A", regular Weight: 750 kg	HIPAC 333	15 µm	26	14.86 kg	+ 28%	263 g
							40%

USAGE INFORMATION



Rotating table

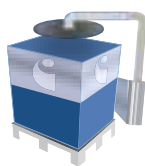

Rotating arm



Robot

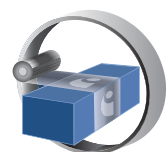

Horizontal rotating ring

111

SUPER POWER

FOR AUTOMATIC
WRAPPING MACHINES
WITH **HIGH PRODUCTIVITY**
AND **HIGH PRESTRETCH**

PREMIUM

- UP TO 400% -

Our sustainable solution to replace traditional super power films allowing **thickness downgauging** whilst maintaining the **stability** and the safety **of the load unit**.

The lower film consumption can **reduce your packaging costs by up to 20%**



Fully recyclable



Efficient and reliable



Safe transportation



20% cost saving



Protection of the goods



Reduction of CO₂ emissions

PREMIUM FILM 111 SUPER POWER IS IDEAL FOR HIGH PRODUCTIVITY APPLICATIONS



HIGH PERFORMANCE
VERY LOW THICKNESS

TECHNICAL INFORMATION

111 FILM vs traditional super power
(17 µm)

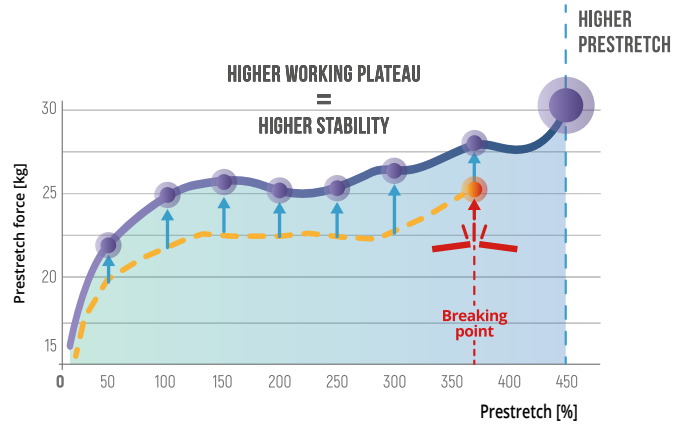

SUGGESTIONS

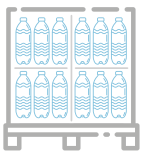

Beverage
17 µm

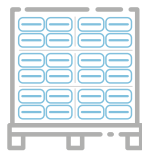

Bags
15 µm

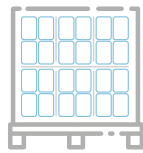

Tissue
12 µm

THE LOAD UNIT IS IN COMPLIANCE WITH EUMOS 40509

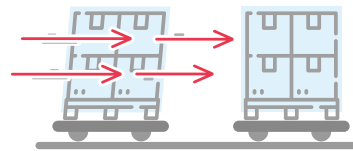

Acceleration Bench Test



0,5g

CUSTOMER FIELD TEST - BEVERAGE

		PRODUCT	THICKNESS	NUMBER OF WRAPS	HOLDING FORCE	HOLDING FORCE DIFFERENCE	FILM CONSUMPTION	FILM SAVING
	Automatic Rotating Ring Prestretch: 250%	SUPER POWER FILM	23 µm	25	9.73 kg		377 g	
	LOAD UNIT TYPE Profile "A", regular Weight: 900 kg	HIPAC 111	17 µm	25	10.22 kg	+ 5%	258 g	32%

USAGE INFORMATION



Rotating table

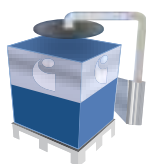

Rotating arm



Rotating ring



Robot

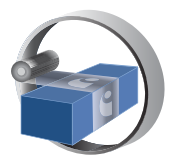

Horizontal rotating ring

112

SUPER POWER PLUS

FOR AUTOMATIC
WRAPPING MACHINES
WITH **VERY HIGH
PRESTRETCH**

PREMIUM

- OVER 400% -

Our sustainable solution to replace traditional Super Power films, specially designed to achieve **extremely high prestretch** in **very low thickness**.

The lower film consumption can **reduce your packaging costs by up to 25%**



Fully recyclable



Extremely high prestretch



Safe transportation



25% cost saving



Protection of the goods



Reduction of CO₂ emissions

PREMIUM 112 IS IDEAL FOR EXTREMELY HIGH PRESTRETCH APPLICATIONS



EXTREMELY HIGH PRESTRETCH
IN VERY LOW THICKNESS

TECHNICAL INFORMATION

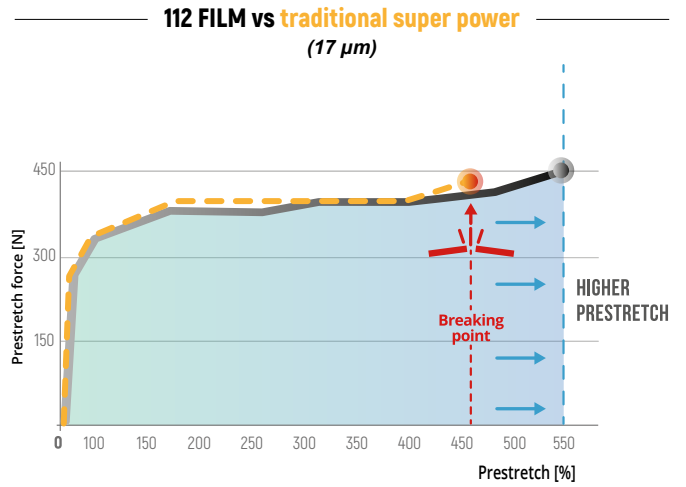

SUGGESTIONS

Try our 112 in very low thickness

GUARANTEED PRESTRETCH



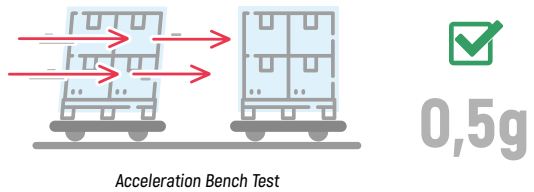

112 SUPER POWER PLUS

THE LOAD UNIT IS IN COMPLIANCE WITH EUMOS 40509



CUSTOMER FIELD TEST - GOODS IN BOXES

	PRODUCT	THICKNESS	NUMBER OF WRAPS	HOLDING FORCE	HOLDING FORCE DIFFERENCE	FILM CONSUMPTION	FILM SAVING
	Robot Adjustable prestretch Up to: 500%	SUPER POWER FILM 15 µm 230% PS	19	14.46 kg		155 g	
	LOAD UNIT TYPE Profile "A", regular Weight: 500 kg	HIPAC 112 12 µm 300% PS	19	13.95 kg	=	105 g	32%

USAGE INFORMATION



Rotating table

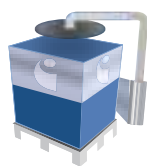

Rotating arm



Rotating ring



Robot

999
EXTRA RIGID

FOR **HAND WRAPPING**
AND FOR
WRAPPING MACHINES
WITHOUT PRESTRETCH

PREMIUM

Gives the load unit excellent stability together with material saving and environmental protection.

999 is available in very low thickness (from 5 μm).



Fully recyclable



Easy and comfortable hand application



Safe transportation

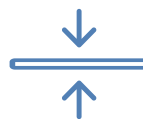

Very low thickness



Protection of the goods



Reduction of CO₂ emissions

PREMIUM FILM 999 PRESTRETCHED IS IDEAL FOR PICKING IN LOGISTICS CENTRES



TECHNICAL INFORMATION

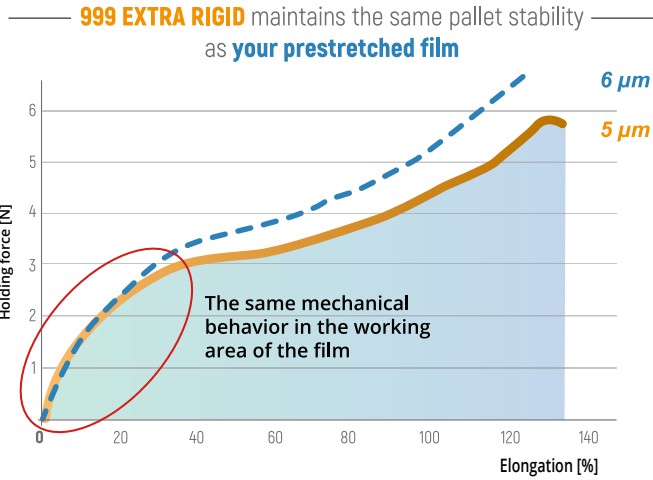

SUGGESTIONS

999 EXTRA RIGID

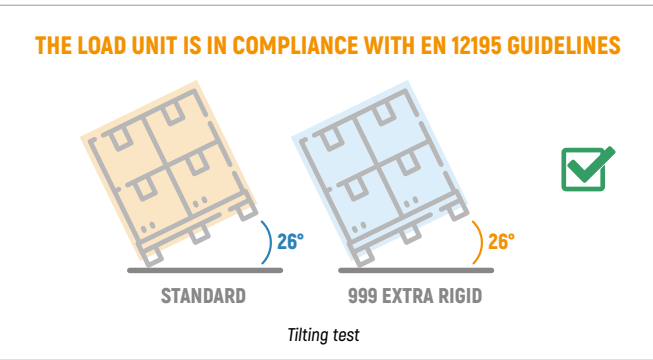
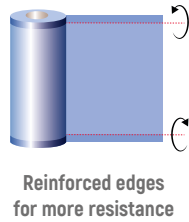
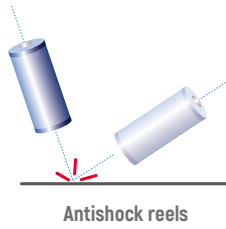
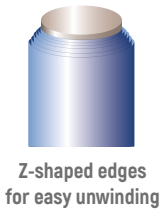

CUSTOMER FIELD TEST - PICKING

		PRODUCT	THICKNESS	NUMBER OF WRAPS	HOLDING FORCE	HOLDING FORCE DIFFERENCE	FILM CONSUMPTION	FILM SAVING
	Hand wrapping	PRE-STRETCHED	6 µm	12	9.00 kg		94 g	
	LOAD UNIT TYPE Profile "A", regular Weight: 400 kg	HIPAC 999	5 µm	12	8.9 kg	=	76 g	19%

USAGE INFORMATION

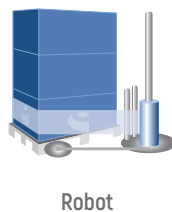



OUR SUSTAINABLE ALTERNATIVE
TO SHRINK FILMS
FOR MULTIPACK
INDUSTRY APPLICATIONS

The Collation Stretch family incorporates Hipac solutions for the cold bundling machines working with stretch film.

The lower film and energy consumption can **reduce your packaging costs by up to 40%**

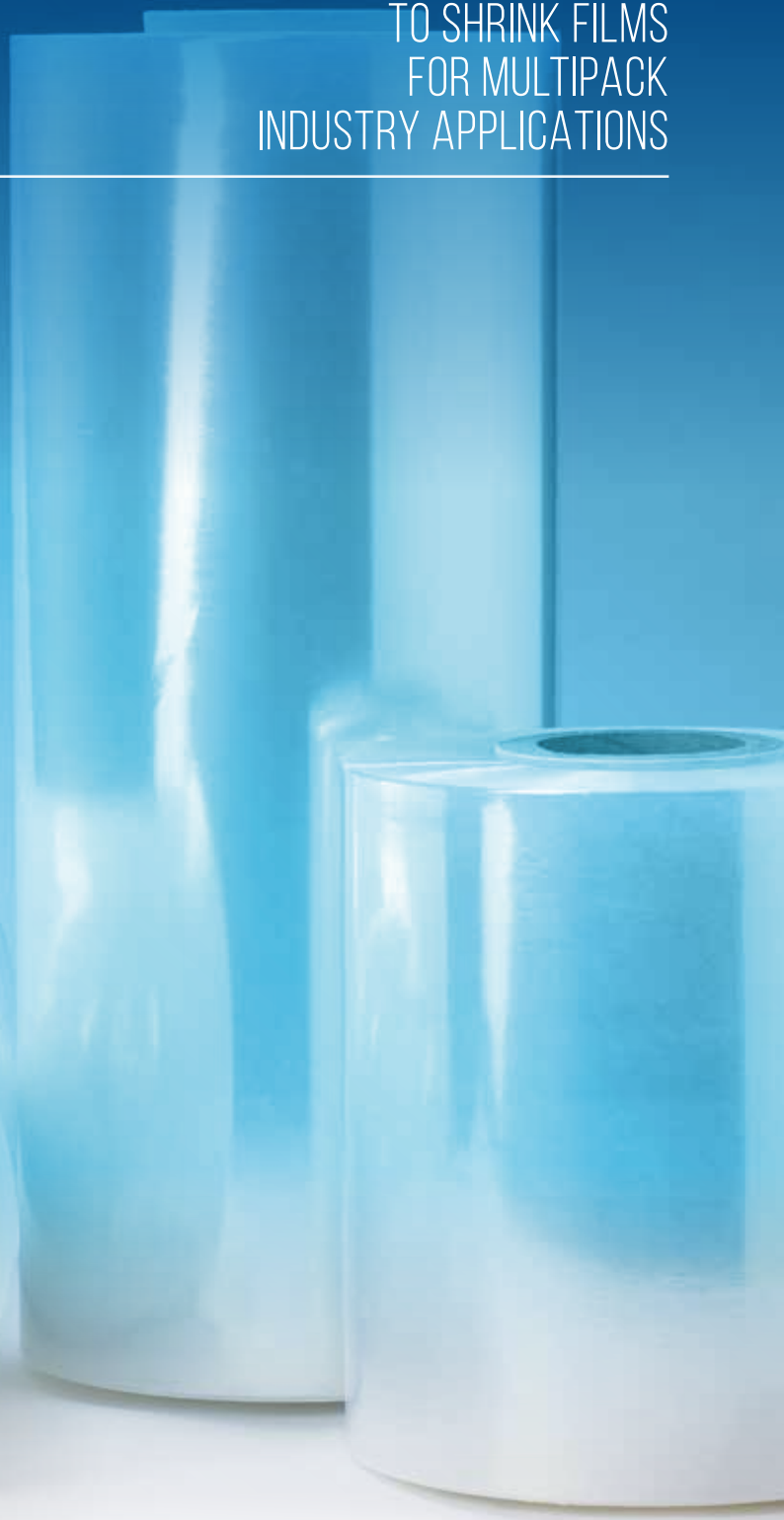
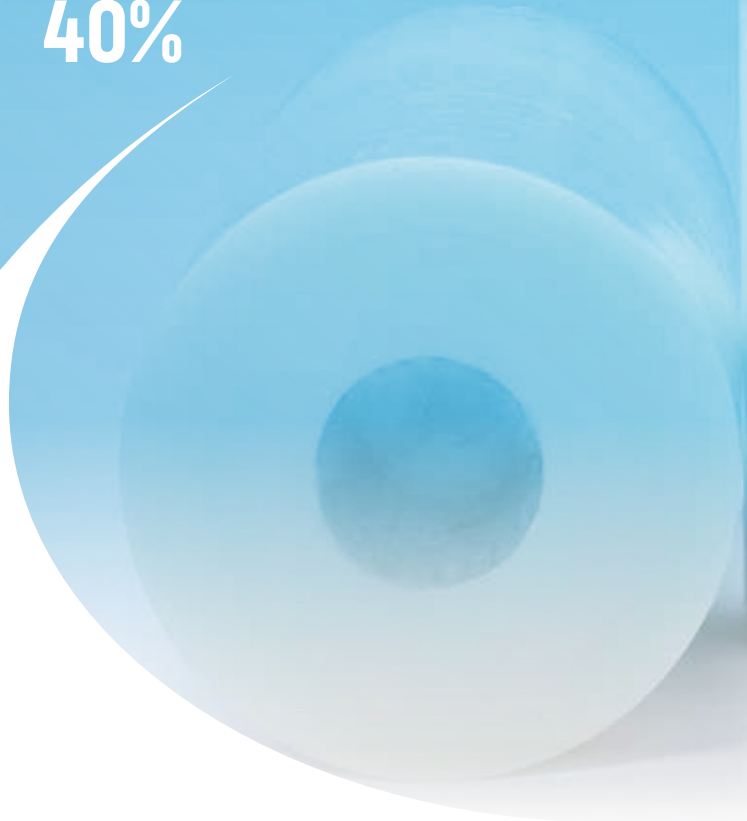

Fully recyclable



Brand recognition



Elimination of the heating tunnel



50% material saving

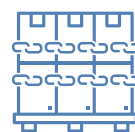

Improved pallet stability



Reduction of CO₂ emissions

COLLATION STRETCH ALLOWS 50% THICKNESS DOWNGAUGING AND 90% ENERGY SAVING (NO HEAT TUNNEL)

CASE STUDIES

WATER



FILM - C202TA500N12

SHRINK FILM
COLLATION STRETCH
MATERIAL SAVING

21 g
11 g
47%

DIAPERS



FILM - C605TA580N15

SHRINK FILM
COLLATION STRETCH
MATERIAL SAVING

30 g
14 g
53%

FLOUR

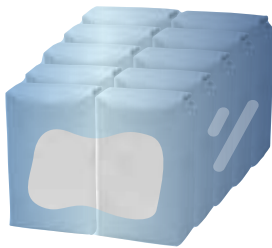

FILM - C201TA500N9

SHRINK FILM
COLLATION STRETCH
MATERIAL SAVING

30 g
12 g
60%

VITAMINS



FILM - C606TA70N40

SHRINK FILM
COLLATION STRETCH
MATERIAL SAVING

1,5 g
1 g
33%

PRODUCT FAMILY

C200 SERIES

For horizontal rotating rings
without pre-stretch

width: 200, 250, 330, 375, 450, 500 mm

thickness: from 7 to 15 µm

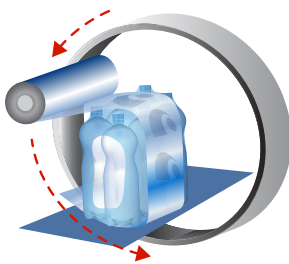

C200 - Rotating Ring

C400 SERIES

For wrapping machines
with pre-stretch

width: 250, 450, 500, 650, 750 mm

thickness: from 9 to 17 µm

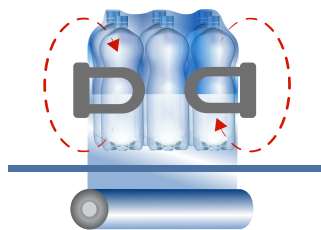

C400 - Rotating Goods

C600 SERIES

For stretch bundler machines

width: tailor made solutions depending
on the pack

thickness: from 12 to 35 µm

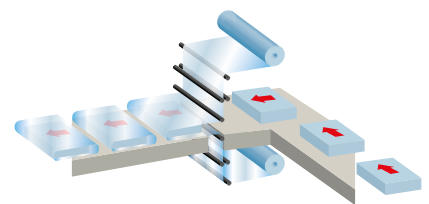

C600 - Bundler

HI GREEN

OUR VISION FOR A GREENER FUTURE



Fully
recyclable



Circular economy



Reduction
of CO₂ emissions



Renewable sources



Reduction of
waste material



No microplastics



No exploitation
of fossil sources



Zero waste

Circular economy

CONAI award of excellence

555 12 µm netroll REC 60
60% CO₂ emissions reduction
80% water consumption reduction



A SECOND LIFE FOR STRETCH FILM!

STRETCH FILMS MADE OF POST CONSUMER AND/OR POST INDUSTRIAL RECYCLED RAW MATERIALS, MECHANICALLY RECYCLED FROM HIGHLY SELECTED WASTE MATERIALS OF THE STRETCH APPLICATION.



REC 30:

Stretch film made of 30% post consumer recycled plastic (PCR), certified with the green labels "Plastic Second Life mix-eco" and "Aenor"

REC 60:

Stretch film made of 60% post consumer recycled plastic (PCR), certified with the green labels "Plastic Second Life from separate waste collection" and "Aenor"

REX 30:

Stretch film made of 30% post industrial recycled plastic (PIR), certified with the green labels "Plastic Second Life mix-eco" and "Aenor"

REX 60:

Stretch film made of 60% post industrial recycled plastic (PIR), certified with the green labels "Plastic Second Life mix-eco" and "Aenor"

REC ISCC:

Stretch film made of lldpe obtained from the industrial treatment of waste materials, in compliance with ISCC plus international standard.



AENOR



Non-exploitation of fossil sources

CO₂ emissions reduction



STRETCH FILMS MADE OF POLYETHYLENE OBTAINED FROM RENEWABLE, NON - FOSSIL SOURCES.

REN 51:

Stretch film made of renewable lldpe obtained from the scraps of sugar cane production, certified with the green label "I'm green".

REN ISCC:

Stretch film made of renewable lldpe obtained from the scraps of the wood industry and inedible vegetal oils, in compliance with ISCC plus international standard.



No microplastics

Reduction of waste material



BIODEGRADABLE, NON - COMPOSTABLE STRETCH FILM, IN COMPLIANCE WITH ISO 15985 INTERNATIONAL STANDARD AND EQUIVALENT.

RES:

The degradation of stretch film is reduced to a **few years**.
The shelf life of biodegradable film does not change, as the degradation only starts upon disposal.
The film remains **100% recyclable**.

HIPAC green solutions are available in NETROLL version to enhance sustainability. CONTACT US FOR MORE INFORMATION ABOUT PRODUCT SPECIFICATIONS AND THEIR AVAILABILITY.

DOUBLEEDGE

FOR HAND AND MACHINE FILMS

**STRETCH FILM WITH REINFORCED EDGES,
FOR GREATER STRENGTH
DURING APPLICATION.**

THE TECHNOLOGY
TO FURTHER REDUCE
THE THICKNESS
OF THE FILM.



Fully recyclable



Efficient and reliable



Safe transportation



Protection of
the goods

FILMS WITH REINFORCED EDGES ARE AVAILABLE FOR HAND AND MACHINE FILMS



ADVANTAGES

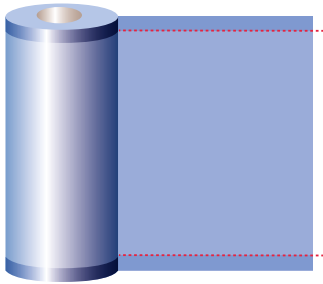

Double thickness
Double resistance



Z-shaped edges
for easy unwinding

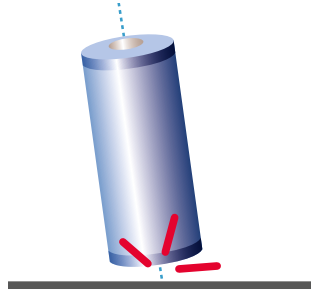

Protection of the reels
from accidental damage



Increased tearing resistance
in transversal direction

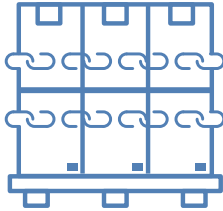

Roping effect
for increased load stability



Higher quality consistency
in hand application
and on wrapping machines

REDUCED CONSUMPTION

Reinforced edge allows a strong reduction of the thickness of the film in application

SUSTAINABLE

Reduction in CO₂ emissions

USER FRIENDLY

Reels are lighter, easier to handle and safe



www.hipac.com

CONTACT US FOR MORE INFORMATION ABOUT PRODUCT SPECIFICATIONS AND THEIR AVAILABILITY.

ECOFRIENDLY SOLUTION WITHOUT PAPER CORE

THE INNOVATIVE TECHNOLOGY
TO "ZERO" YOUR WASTE



Fully
recyclable



Light
and comfortable



Economic

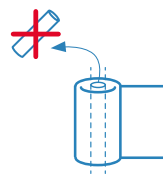

Elimination of
the paper core



Reduction
of CO₂ emissions



Water footprint
reduction

NO CORE, SAME PERFORMANCE



Use it as a traditional reel with the new dispenser **HANDYNET**.



Use it as a traditional reel as it fits all the wrapping machines.

ADVANTAGES

USER FRIENDLY

Same performance as core films

Reels are lighter, easy to handle and safe

ECONOMIC

The reel is cheaper

No more green taxes on the paper core

No disposal costs on the paper core

Optimization of logistics transport costs

SUSTAINABLE

Reduction in CO₂ emissions

Reduction in energy consumption

Reduction in water footprint





▶ HANDYNET ◀

THE NEW DISPENSER FOR HAND FILM

HIPAC HAS DEVELOPED THE NEW DISPENSER FOR HAND NETROLL FILM, 450 AND 500 MM WIDTH.

A BRAND NEW SOLUTION TO WRAP YOUR PALLETS IN A SAFER AND EASIER WAY!



Fully recyclable



Easy and comfortable hand application



Reuse Zero waste



Customized



Reduction of CO₂ emissions



Light and comfortable

THE DISPENSER IS MADE OF A SPECIAL POLYOLEFIN PE/PP MIX, TO GIVE IT LIGHTNESS AND SHOCK RESISTANCE AT THE SAME TIME. IT IS FLEXIBLE AND ADJUSTABLE TO THE HOLE OF THE REELS. ITS DUMBBELL SHAPE AND THE ROTATION OF THE HANDLES GUARANTEE A SMOOTH UNWINDING OF THE REEL.



LIGHT AND FLEXIBLE



ANTISHOCK



Its peculiar shape has been especially developed to **avoid the damage of the reels** both during the wrapping process and in the case the reel is mishandled or falls.



EASY

Light and comfortable, the dispenser can be used without gloves.

CUSTOMIZED

The dispenser can be **customized with the colour and logo of your company**.

SUSTAINABLE

By eliminating paper cores, the CO₂ emissions for each pallet of stretch film is reduced **by 98 kg**, equivalent to a **500 km trip with a mid-sized car**.

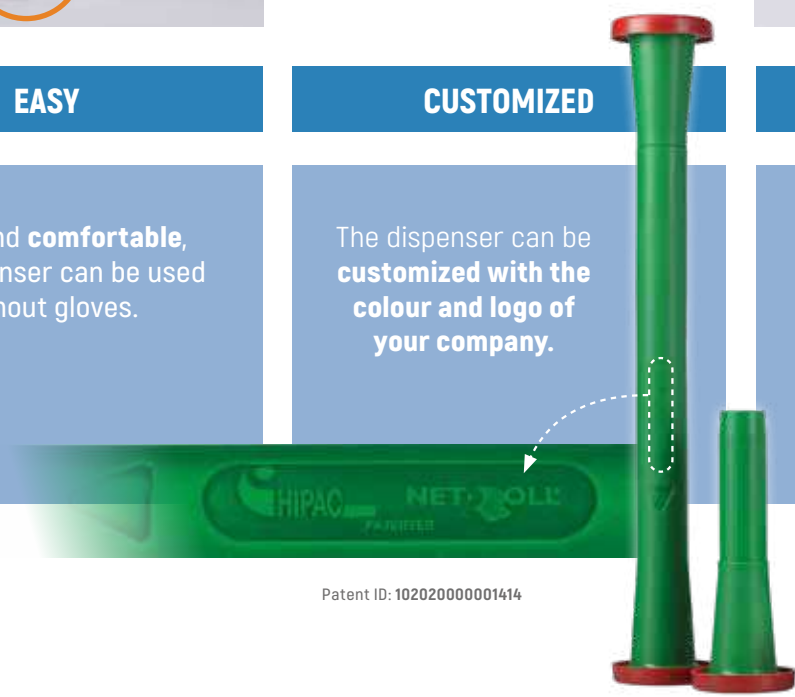

Patent ID: 102020000001414

▶ EASYNET ◀

NEW ADAPTER FOR NETROLL MACHINE FILM

IT ALLOWS NETROLL MACHINE FILM
TO FIT ALL WRAPPING MACHINES
WITH TOP REEL LOADING.



Fully
recyclable

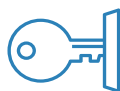

Universal



Customized



Ecological

EASYNET IS A QUICK AND SUSTAINABLE SOLUTION TO USE MACHINE NETROLL FILM WITH MOST OF THE WRAPPING MACHINES AVAILABLE IN THE MARKET. THERE IS NO NEED TO CHANGE THE REEL HOLDER OF THE MACHINE.



HOW TO USE EASYNET

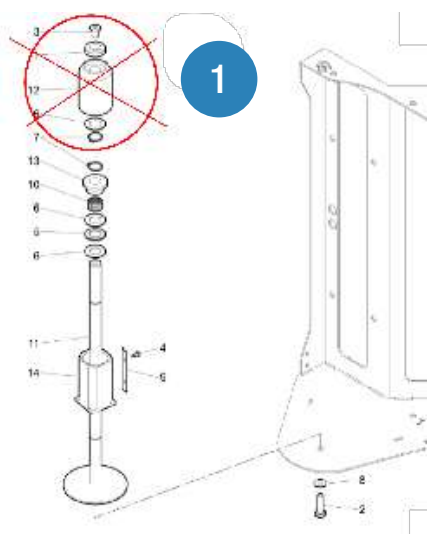

- ① Unscrew and remove the reel holder at the upper section of the spool carriage.
- ② Put the **NETROLL** reel on the machine, as usual.
- ③ Fit **EASYNET** adapter on top.

UNIVERSAL

It allows **NETROLL** machine film to fit all wrapping machines.

CUSTOMIZED

With your own colour and brand.

ECOLOGICAL

Made of bio material, obtained from renewable sources.



PRODUCT DATA SHEET



LLDPE CAST CO-EXTRUDED STRETCH FILM FOR INDUSTRIAL PACKAGING.

QUALITY		HAND USE internal core diameter: 50 mm		MACHINE USE internal core diameter: 76 mm		BUNDLING internal core diameter: 38-50-76 mm	
		THICKNESS [µm]	WIDTH [mm]	THICKNESS [µm]	WIDTH [mm]	THICKNESS [µm]	WIDTH [mm]
T R A D I T I O N A L	310			20-35	500		
	308	15-50	450-500	15-50	250-450-500-750-1000	15-50	70-100-125-150-250
	388	15-50	450-500	15-50	250-450-500-750-1000	15-50	70-100-125-150-250
	888			12-35	250-450-500-750-1000	12-35	70-100-125-150-250
	777			12-35	250-450-500-750-1000	12-35	70-100-125-150-250
P R E M I U M	111			10-35	250-450-500-750-1000	10-35	70-100-125-150-250
	112			10-23	500-750-1000	10-23	70-100-125-150-250
	333			9-23	250-450-500-750-1000	9-23	70-100-125-150-250
	555	7-23	450-500	7-23	250-450-500-750-1000	7-23	70-100-125-150-250
	999	5-10	380-420	7-10	420		
C O L L A T I O N	C200 SERIES			7-15	200-250-330-375-450-500		
	C400 SERIES			9-17	250-450-500-650-750		
	C600 SERIES			12-35	TAILOR MADE SOLUTIONS		

STANDARD PRODUCTION.

CONTACT US FOR SPECIAL REQUEST.

NetRoll HOLE diameter: 50 mm for hand film; 74 mm for machine film.

Cling side: internal (standard production), external or both. Extra cling available upon request.
Slippery side: upon request on internal or external layer. Extra slippery available upon request.

OPTIONAL FEATURES

1 Colours

BI200	NE200	GR100	BL100
BI300	NE300	GR300	BL200
Customized colours available upon request			BL300
VE100	GI100	AR160	RO100
VE200	GI200	AR300	RO200
VE300	GI300		RO300

2 Printed film up to 3 colours, with eco-friendly water-based inks



3

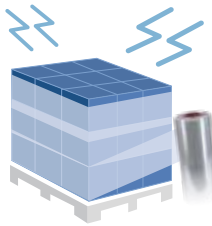

Antistatic film: reduction of electrostatic charges and dust on the pallet.

4

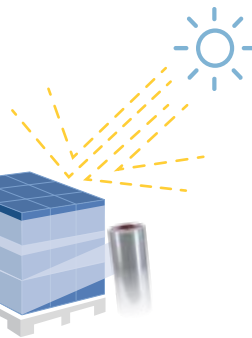

Anti UV film: protection of the film against UV rays (6-12 months).

5

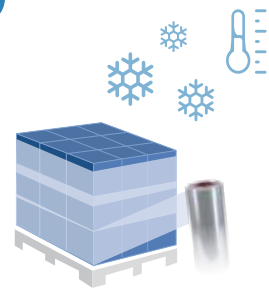

Low Temperature film Lt: best performance in extreme conditions (-25°C).



6

Anticorrosive (VCI) film: protection of steel products from oxidation.



7

HIPAC Pure: antimicrobial film, protection against microorganisms, bacteria, fungi.



HIPAC QUALITY

Targeting a specific sector of the global packaging market and making high-quality products is paramount to HIPAC.

To this end, **HIPAC Group** has decided to implement an integrated organizational model, approved and certified according to the internationally recognized standards **UNI EN ISO 9001, 14001, 45001 and 50001**.



ISO 9001 "Quality Management System"

requires that all the organizational, commercial and technical activities which have influence on quality are planned, controlled and documented.



ISO 45001 "Occupational Health and Safety"

allows Hipac to identify and control risks related to health and safety at work, reducing the number of potential accidents, in compliance with the existing legislation.



ISO 14001 "Environmental Management System"

guarantees the control of all the environmental aspects of both product and process, in compliance with the existing legislation.



ISO 50001 "Energy Management System"

guarantees Hipac ethical commitment to energy saving and improvements in energy efficiency.



HIPAC S.p.A.

Via per Rovato, 10
25046 Cazzago S. Martino (BS)
ITALY
Phone +39 030 77 50 610
Fax +39 030 77 50 847





IBERHIPAC S.A.

Ctra. N-V, Km. 189,1
10390 Saucedilla (Cáceres)
España Apartado Postal no 134
10300 Navalmoral de la Mata (Cáceres)
ESPAÑA
Phone +34 927 54 51 88
Fax +34 927 54 51 87



HIPAC ROMANIA S.R.L.

Sat Dragomirești-Deal, Aleea
Constanza Nr. 1, Judetul Ilfov,
077095 Comuna Dragomirești - Vale
ROMÂNIA
Phone +40 21 35 23 600
Fax +40 21 35 23 608



PRODUCT RANGE



www.hipac.com